

Model: TDL3070

Description: Handmade Sink – Double Bowl
60/40 15mm Radius

Material/Gauge: 304 – 18/8 Stainless Steel, 16
Gauge

Mounting Option: Under Mount (clips included)

Suggested Cabinet Size: 34" or Larger

Outside Sink Dimensions: 32" x 19" x 10"

Accessories Included: Deluxe Drains Model
TDL9000

Optional Accessories: Grid Model TDL2097-SET,
Standard Drain Model TDL9005

Available as a Package: Yes, Model TDL3070-
PKG

Accessories Included in the Package: Bottom
Grids & Deluxe Drains

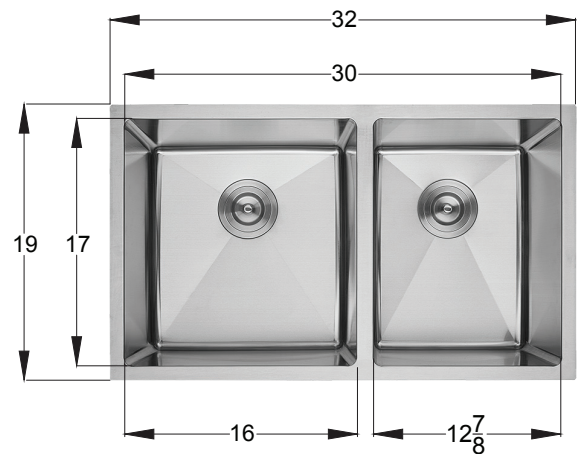

NOTES:

- Sink sizes can vary up to 1/8 of an inch. All sink cutouts should be verified with the sink upon purchase.
- Cabinet sizes are typically listed as outside dimensions, therefore approximately 1 1/2" (3/4" on each side) should be removed when considering sink options.
- Please refer to our warranty, guide to care and maintenance and installation sections of this catalogue for more information on all of our products and services.
- We encourage you to visit our website for links to our sink specifications and/or DXF files.