

Model: TDL1070

Description: Pressed Sink – Double Bowl 70/30 Offset

Material/Gauge: 304 – 18/8 Stainless Steel, 18 Gauge

Mounting Option: Under Mount (clips included)

Suggested Cabinet Size: 33" or Larger

Outside Sink Dimensions: 31 1/2" x 20 1/2" x 9"

Accessories Included: Standard Drains Model TDL9005

Optional Accessories: Grid Model TDL1097-SET, Deluxe Drain Model TDL9000

Available as a Package: Yes, Model TDL1070-PKG

Accessories Included in the Package: Bottom Grids & Deluxe Drains

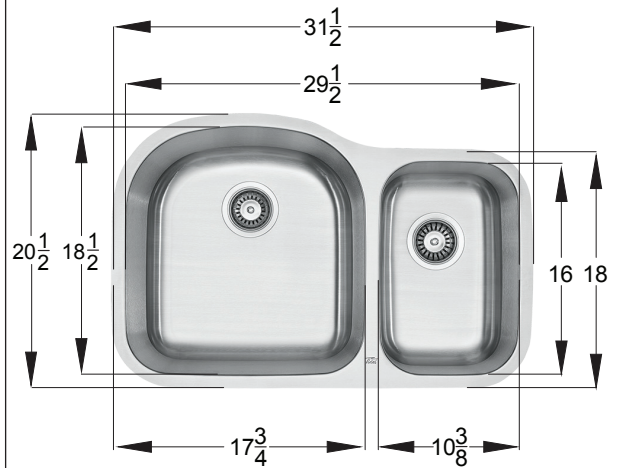

NOTES:

- Sink sizes can vary up to 1/8 of an inch. All sink cutouts should be verified with the sink upon purchase.
- Cabinet sizes are typically listed as outside dimensions, therefore approximately 1 1/2" (3/4" on each side) should be removed when considering sink options.
- Please refer to our warranty, guide to care and maintenance and installation sections of this catalogue for more information on all of our products and services.
- We encourage you to visit our website for links to our sink specifications and/or DXF files.