



Tidal Sinks Plus Ltd. - P.O. Box 10029 - Winona - Ontario - L8E 5R1

Model: TDL1060-PKG

Sink Specifications

Description: Double Bowl Sink- 60/40 Offset Package

Outside Dimensions: 32 1/4" x 20 5/8" x 9"

Material: 304- 18/8 Stainless Steel

Mounting Option: Under Mount (clips included)

Finish: Ultra Satin

Thickness: 18 Gauge

Sound Proofing: Sound Pads & Undercoating

Warranty: Limited Lifetime

Drain Size: Standard 3 5/8"

Certification: CUPC (Canada)

Cabinet Size: 34" or Larger

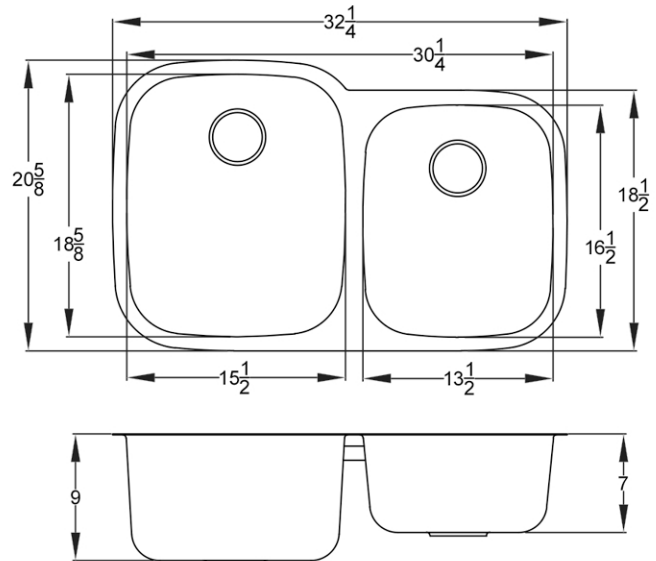

Tidal Sinks Plus Ltd is a 100% Canadian owned company, based in southern Ontario.

Our goal is to provide quality sinks that compliment your everyday lifestyle.

Customer service and satisfaction is our top priority.

We have a number of models to choose from - please visit our website to view our full offering.

Included accessories:

Grid: TDL1096-SET

Deluxe Drain: TDL9000

Optional accessories:

Standard Drain: TDL9005

Certification:



For more information on this model, or any other Tidal product, please visit our website www.tidalsinks.com or contact your local retailer for details.

Note that the drawings, templates and .dxf files provided here and on the website are intended to be used as a guide for cutout purposes - please ensure that all sinks are measured and confirmed prior to cutting / installation. Due to manufacturing machinery and/or hand made items, Tidal Sinks Plus Ltd. cannot be held responsible for differences in sink measurements.

The Right Sink